

*CHEYENNE*<sup>®</sup>

# HAWK PEN UNIO

---

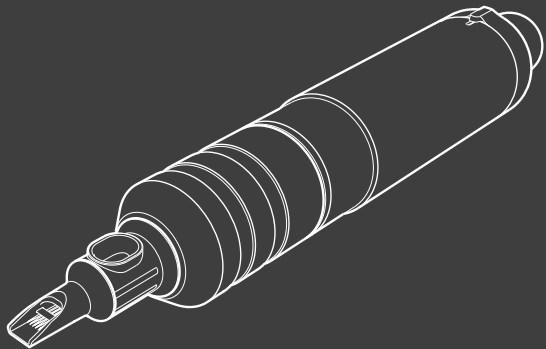

Gebrauchsanweisung  
Instruction for use  
Gebruiksaanwijzing  
Manuel d'utilisation  
Istruzioni per l'uso  
Instrucciones de uso

Manual de instruções  
Οδηγίες  
Opis  
Bruksanvisning  
Ohjeet  
Instrukcja obsługi

Instrukce  
Navodila nt pl za uporabo  
Utasítás  
Инструкция  
使用说明书

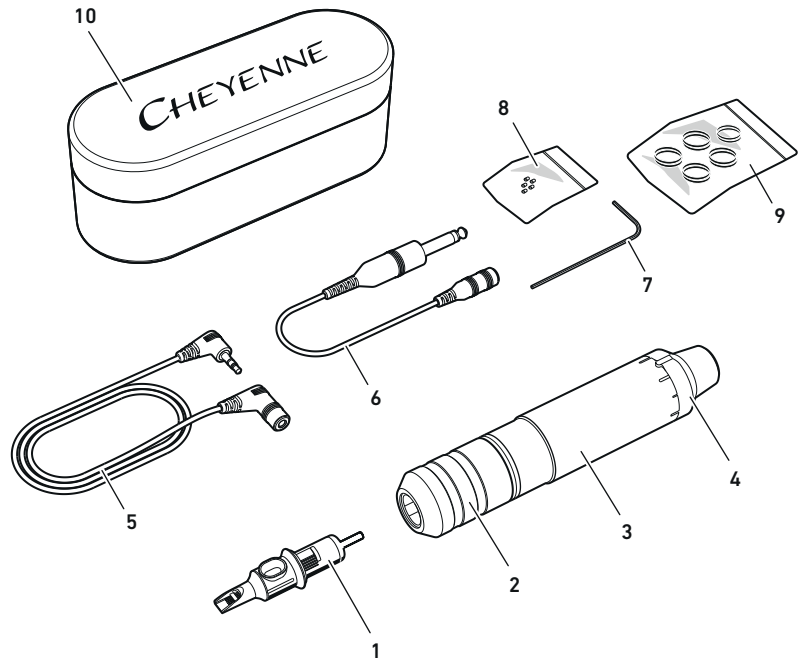

*CHEYENNE*<sup>®</sup>  
**HAWK PEN**  
**UNIO**

Cheyenne HAWK Pen Unio

Translation of the original operating instructions. The original operating instructions were written in German.

**CHEYENNE®**  
**HAWK PEN**  
**UNIO**

## Instruction for use

### Table of Contents

1	About this instruction for use.....	27	6	Using the tattoo machine.....	37
1.1	Warning symbols and statements used in this instruction for use.....	27	6.1	Setting the needle depth.....	37
2	Important safety notices.....	28	6.2	Setting the stitch frequency.....	37
2.1	General Safety Information.....	28	6.3	Setting the stroke.....	37
2.2	Product-dependent safety information.....	28	6.4	Loading with ink.....	38
2.3	Important hygiene and safety regulations.....	28	7	Cleaning and maintaining the tattoo machine.....	38
2.4	Purpose and contraindications.....	29	7.1	Material compatibilities.....	38
2.5	Risks.....	30	7.2	Disinfecting surfaces.....	39
2.6	Required qualification.....	30	7.3	Cleaning surfaces.....	39
2.7	Intended use.....	30	7.4	Cleaning the drive ram.....	39
2.8	Symbols on the product.....	31	7.5	Cleaning grip in an ultrasonic bath.....	40
3	Scope of delivery.....	32	7.6	Sterilizing grip in an autoclave.....	40
4	Product information.....	32	7.7	Cleaning or replacing o-rings.....	40
4.1	Technical Data.....	32	8	Transport and storage conditions.....	41
4.2	Operating conditions.....	32	9	Disposal of equipment.....	41
4.3	Accessories.....	32	10	For questions or problems.....	41
5	Preparing the tattoo machine for use.....	33	11	Manufacturer Declarations.....	42
5.1	Checking equipment.....	33	11.1	Disclaimer of warranties.....	42
5.2	Disinfecting equipment.....	33	11.2	Declaration of Incorporation.....	43
5.3	Connecting the power unit.....	34			
5.4	Fitting the protective sleeve.....	35			
5.5	Replacing the needle cartridges.....	35			

## 1 About this instruction for use



This operating manual applies to Cheyenne tattoo machine HAWK Pen Unio and their accessories. It contains important information about how to operate and maintain these products safely and in the intended manner.

This operating manual does not contain all of the information needed for safe operation of tattoo machines and their accessories. Therefore, observe the following additional documents:

- Operating manual for the Cheyenne Power Unit and/or an external power unit and, if applicable, a foot switch
- Information about needle cartridges and tattoo inks
- Safety data sheets about disinfectants and cleaning agents
- Health and safety information and statutory provisions relating to tattooing

### 1.1 Warning symbols and statements used in this instruction for use

Warning notices draw attention to the risk of personal injury and damage to materials and are structured as follows:

 <b>SIGNAL WORD</b>	
<b>Type of hazard</b>	
Consequences	
▶ Remedy	
Element	Meaning
	Indicates a risk of injury
Signal word	Specifies the severity of the hazard (see table below)
Type of hazard	Gives the type and source of the hazard
Consequences	Describes potential consequences of non-compliance
Remedy	Indicates how to avoid a hazard

Signal word	Meaning
Hazard	Indicates a hazard that will definitely lead to death or to serious injury if the hazard is not avoided
Warning	Indicates a hazard that may lead to death or to serious injury if the hazard is not avoided
Caution	Indicates a hazard that can lead to minor to relatively serious injury if the hazard is not avoided
Attention	Indicates potential risks to the environment, property or equipment if this hazard is not avoided

Symbols used in this operating manual

Symbol	Meaning
▶	Call for action
•	List point
-	List sub-point

## 2 Important safety notices

---

### 2.1 General Safety Information

- ▶ Keep your tattoo machine away from children.
- ▶ Carefully read this entire operating manual.
- ▶ Keep the operating manual in a readily accessible location for everyone who uses, cleans, disinfects, sterilizes, stores or transports the machine.
- ▶ When sharing your tattoo machine with someone else, always enclose this operating manual.
- ▶ Follow the safety regulations applicable to tattooing in your country. Keep your tattoo studio in a hygienic, clean condition and provide sufficient lighting.
- ▶ Only use your tattoo machine, its accessories and the power unit as well as all connecting cables when they are in perfect working order.

- ▶ Only use genuine needle cartridges, accessories and spare parts from Cheyenne.

### 2.2 Product-dependent safety information

- ▶ Never modify the machine, the needle cartridges or their accessories.
- ▶ Prevent fluids from entering the drive unit.
- ▶ During the tattooing process, protect all parts with a protective sleeve (see chapter 5.4 on page 35).
- ▶ If you are not using your tattoo machine, switch it off and place it in a secure location so that it cannot roll away and fall down.
- ▶ Note the technical data quoted in this operating manual and comply with operating, transport and storage conditions (see 4 on page 32).
- ▶ Hand over the machine to a specialist retailer for inspection if it exhibits any external signs of damage or if it does not function in the usual manner.

### 2.3 Important hygiene and safety regulations

To prevent infectious diseases as a result of tattooing from being transmitted to the client or to the tattoo artist:

- ▶ Before use, follow the steps required to disinfect the equipment (see chapter 5.2 on page 33).
- ▶ During the tattooing process, wear disposable nitrile or latex gloves and disinfect them before use.
- ▶ Before applying a tattoo, clean the affected areas of the customer's skin with a mild cleaning and disinfectant agent. When selecting an appropriate disinfectant, take note of the applicable regulations in your country.
- ▶ For each client always use new, sterile-packaged needle cartridges. Before each usage, ensure that the packaging is undamaged and that the use-by date has not passed.
- ▶ Dispose of used or defective needle cartridges in a sharps container (safety box) in accordance with your country's regulations.

- ▶ Prevent needle cartridges from coming into contact with contaminated objects, e.g. clothing. Dispose of contaminated needle cartridges immediately.
- ▶ Always use dermatologically safe inks designed specifically for tattooing.
- ▶ Avoid contact with freshly tattooed skin. Protect freshly tattooed areas of skin from dirt and from exposure to UV light and sunlight.
- ▶ Check regularly to determine whether there is visible soiling of the tattoo machine. If this has happened, in addition to regular disinfection, you must perform all the steps described in the chapter 7 on page 38.

## 2.4 Purpose and contraindications

### 2.4.1 Purpose

The purpose is the minimally invasive injection of sterile or aseptic pigment color of mineral or organic origin into the dermis by means of micropigmentation (tattooing).

The skin does not bear any open wounds given the minimally invasive puncturing of the epidermis (top layer of skin) and dermis (middle layer of skin). Therefore, the skin needs only a very short regeneration phase during which the epithelial function is quickly restored.

### Application area

Body tattooing

### 2.4.2 Contraindications

Tattooing is **not** permitted in case of the following:

- Haemophilia/blood vessel conditions
- Current consumption of blood thinners (e.g. Warfarin, Heparin, acetylsalicylic acid)
- Uncontrolled diabetes mellitus
- Any form of active acne in the skin region to be tattooed
- Dermatitis (e.g. skin tumors, keloids or extreme inclination for keloid formation, solar keratosis, warts and/or moles) in the skin region to be tattooed

- Open wounds and/or eczema and/or skin rashes in the skin region to be tattooed
- Scars in the skin region to be tattooed
- Systemic infections and infectious diseases (e.g. hepatitis A, B, C, D E or F; HIV infection) or acute local skin infections (e.g. herpes, rosacea)
- During chemotherapy, radiotherapy or high-dosage corticosteroid therapy (recommendation: less than four weeks before the beginning until four weeks after the end of the therapy)
- Up to twelve months after plastic surgery in the skin region to be tattooed
- Up to six months after filler injections in the region to be tattooed
- Under the influence of alcohol and/or drugs
- Pregnancy and lactation

Treatment of mucous membranes and eyeballs is strictly prohibited.

The treatment must be terminated immediately in the event of:

- Excessive sensations of pain
- Fainting / dizziness

## 2.5 Risks

In some cases, minor side effects can appear during and after the tattooing process, as described below.

### Frequent:

- Local bleeding in the region of the skin surface to be tattooed
- Pain and discomfort on the day after tattooing
- Temporary inflammatory reactions, erythema and/or edema up to 6 days after tattooing
- Skin irritations (e.g. itching or heating), which normally wear off during the first 12 to 72 hours after the tattooing process
- Scabbing, which normally recedes within the first 5 days
- Temporary flaking of the skin, which normally wears off within 8 days

### Rare:

- Formation of blisters of the herpes-simplex virus type I (HSV-I)
- Formation of small pimples or skin eruptions if skin is not cleaned carefully after the tattooing process
- Hyper-pigmentation with body's own pigments, in particular on dark skin types, but which disappear completely within a few weeks
- Retinoid reaction (slight irritation up to peeling of skin)
- Possible warming of the pigmented area when exposed to PET and MRT radiation

As a general rule, recently treated areas of skin should be protected from UV radiation and sunlight.

### Furthermore, the following problems may occur in response to tattooing:

- Ink shade differences
- Pigment loss
- Allergic reactions to components of the aseptic pigment color

## 2.6 Required qualification

The tattoo machine must only be used by those who have acquired the following knowledge:

- Basic knowledge of the tattooing process, in particular correct insertion depth and frequency
- Knowledge of the hygiene and safety regulations (see chapter 2.3 on page 28)
- Knowledge of the impact of tattoo ink below the skin
- Knowledge of the risks and side effects (see chapters 2.4.2 on page 29 and 2.5 on page 30).

## 2.7 Intended use

► The treatment must be performed in a dry, clean and smoke-free environment, and under hygienic conditions. The device must be prepared, used and maintained in the manner described in this operating manual. In particular, the applicable provisions for workplace layout must be observed, and the materials to be used must be sterile.

- ▶ Intended use also includes thoroughly reading and fully understanding this operating manual, in particular the information relevant to safety.
- ▶ The intended use exclusively includes the following consumer groups: persons of lawful age who are in a good state of health.

Unintended use is defined as using the device or its accessories in a way other than as described in this operating manual, or failing to comply with its operating conditions. Treatment of contraindication in particular is prohibited.

## 2.8 Symbols on the product

The following symbols can be found on the machine, its accessories or packaging:

Symbol	Meaning
	Refer to operating manual!

	The product satisfies the applicable requirements stipulated in the European Community harmonization regulations.
	Manufacturer
	Date of manufacture
	Catalog number
	Serial number
	Lot code
	Sterilized with ethylene oxide
	Use-by date
	Attention!
	Temperature limit
	Humidity limit
	Store in a dry place

	Fragile
	Cannot be used if packaging is damaged
	Do not reuse!
	Old electronics, batteries and battery packs must not be disposed of in household waste, but instead must be disposed of professionally.
	The product satisfies the applicable requirements stipulated in legal regulations of the United Kingdom.



### 3 Scope of delivery

---

- 1 Cheyenne HAWK Pen Unio
- 1 Connecting cable
- 1 Cable adapter (6.3 mm jack to 3.5 mm socket)
- 1 Instruction for use
- 1 Case
- 1x service wrench 1.5 mm
- 1x o-ring set (5 pairs)
- 1x screw set (5 x M3 x 3)

### 4 Product information

---

The Cheyenne tattoo machine HAWK Pen Unio as a high-performance device is much quieter and vibrates less than conventional tattoo machines. It has powerful skin piercing power and stitch frequency.

#### 4.1 Technical Data

Nominal voltage	6 to 12.5 V DC
Power intake	4.5 W
Start-up current	Max. 2.5 A for max. 200 ms
Stitch frequency	60 to 140 Hz
Stroke	2.5 mm to 4.0 mm
Needle depth	0 to 4.0 mm
Electrical connection	3.5 mm jack
Drive	DC motor
Operating mode	Continuous operation
Diameter	29 mm
Length	138 mm
Weight	Approx. 160 g
Emission sound pressure level	max. 70 dB (A)
Vibration total value	max. 2.5 m/s <sup>2</sup>

#### 4.2 Operating conditions

Ambient temperature	+10 °C to +35 °C +50 °F to +95 °F
Relative humidity	30% to 75% non-condensing

#### 4.3 Accessories

The following accessories can be purchased from your local specialist retailer:

- Cheyenne tattoo needle cartridges
- Cheyenne Power units
- Cheyenne Foot switch
- Cheyenne Grips
- Cable adapter
- Disposable grips

Protective sleeves must have a diameter of 34 – 40 mm. This corresponds to a sleeve width of 54 – 63 mm.

## 5 Preparing the tattoo machine for use

### NOTICE

#### Damage from condensate

If the machine is exposed to significant variation in temperature, e.g. during transport, condensate can form inside, which may cause damage to the electronics.

- ▶ Ensure that the machine has reached ambient temperature before using it. If it was exposed to high temperature fluctuations, wait for at least 3 hours for every 10 °C of temperature difference before putting it into operation.
- ▶ Only use the device at ambient temperatures of +10 °C to +35 °C.

## 5.1 Checking equipment

- ▶ Conduct a visual inspection of the equipment:
  - Are there any visible signs of external damage (e.g. loose or bent components?)
  - Are there any exposed cables?
  - Are the needle cartridge and the needles correctly aligned?
- ▶ Switch on the machine and conduct a noise test: Can you hear any unusual operating noises, or is the unit running loudly?
- ▶ If you detect anything unusual, refer to chapters 10 on page 41 and 11.1 on page 42.
- ▶ If the machine is no longer operating safely, take it out of service and consult your local specialist retailer.

## 5.2 Disinfecting equipment

### NOTICE

#### Damage to drive caused by fluid

If disinfectant gets inside the drive, this may corrode the electrical and mechanical components.

- ▶ Never immerse the drive in disinfectant.

### NOTICE

#### Product damage caused by non-approved disinfectants

Disinfectants that are not compatible with the materials of the product may damage its surface.

- ▶ Always use disinfectants that are approved, i.e. that comply with stipulations in your country.
- ▶ Note the list of recommended disinfectants in chapter 7.1 on page 38.

- ▶ Turn the tattoo machine off completely.
- ▶ Check if the machine has become heavily contaminated by the return flow of inks or bodily fluids. In such cases, perform the steps described in chapter 7.3 on page 39 .
- ▶ Wipe down the machine cables, the drive and the grip with a soft cloth moistened with disinfectant.

### 5.3 Connecting the power unit

#### CAUTION

##### Risk of short-circuit

If cable or cable connection is visibly damaged, there is a risk of damage to the electronics.

- ▶ Perform a visual inspection of the tattoo machine and the cable for signs of damage, e.g. a defective cable connection.
- ▶ Never bend the connecting cable while in operation.
- ▶ Observe the operating manual for the particular power unit.

#### CAUTION

##### Cables constitute a trip hazard

People may stumble over inappropriately routed cables and get injured.

- ▶ Route all cables so that no-one can stumble over them or pull them accidentally.

There are three ways to supply power to the machine:

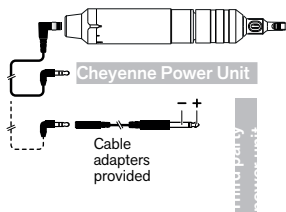

1. Connecting it to a Cheyenne power unit with the connecting cable provided in the scope of delivery (recommended).
2. Connection to a third-party power unit with the 6.3 mm jack and the cable adapter supplied. The exter-

nal power unit must deliver approx. 6 to 12.5 V DC direct current and the required start-up current indicated in chapter 4.1 on page 32. If more than about 13.5 V is connected to the machine, it will shut down automatically.

3. Connection to an external power supply using the optionally available Y-cable adapter with banana plugs. The red banana plug must be connected to the positive terminal while the black banana plug must be connected to the negative terminal of the third-party power unit.
- ▶ Connect the socket of the connecting cable from the scope of supply to the connection on the drive unit of the machine.
  - ▶ Plug the jack of the machine cable fully into the output socket on the power unit. If you are using the third party power unit, connect its terminals correctly, as described in the operating instructions of the third party power unit.

- ▶ Connect the power unit to the mains power supply.
- ▶ Cover the power unit or the third party power unit with a protective film.

#### 5.4 Fitting the protective sleeve

##### ⚠ CAUTION

##### Infection from contaminated protective sleeve

Failure to replace the protective sleeve for the grip can lead to a transmission of illnesses.

- ▶ Use a new protective sleeve for the grip for each customer.

##### NOTICE

##### Damage to drive caused by fluid

If fluid gets inside the drive or on the connection, this can corrode the electrical and mechanical components.

- ▶ Always use a protective sleeve (1) with a suitable diameter (see Chapter 4.3 on page 32).

- ▶ Remove the connecting cable from your tattoo machine.
- ▶ Cut off a section of protective sleeve of an appropriate length.
- ▶ Slide the section of protective sleeve completely over the connecting cable.
- ▶ Completely unscrew the grip (1) from the drive.

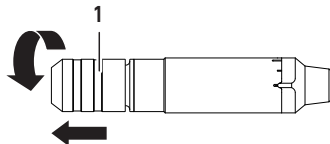

- ▶ Re-connect the connecting cable and its fitted protective hose to the tattoo machine.
- ▶ Pull the end of the protective sleeve (2) completely over your tattoo machine.

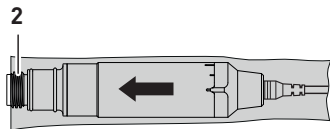

- ▶ Screw the grip (1) back onto the thread of the drive unit.

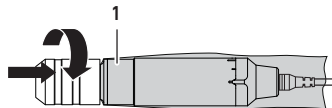

#### 5.5 Replacing the needle cartridges

##### ⚠ WARNING

##### Risk of injury from needles

Injuries caused by contaminated needles from the needle cartridges can lead to the transmission of disease.

- ▶ Always use original Cheyenne needle cartridges for the tattoo machine. The installed safety membrane on these needle cartridges prevents the ingress of ink into the drive, and also prevents pathogens from entering the appliance.
- ▶ Never hold the needle cartridge by its tip or the bayonet connector.
- ▶ Switch off the tattoo machine before changing the needle cartridge.

- ▶ Ensure that when removing a used needle cartridge, no ink remnants can run into the grip.
  - ▶ Never push the needles out of the needle cartridge.
  - ▶ Check during the removal of a used needle cartridge that the needles are completely retracted into the needle cartridge.
  - ▶ Dispose of used needle cartridges that are no longer required for the current application (see chapter 9 on page 41).
  - ▶ The needle cartridges are supplied in sterile packaging. Do not remove them from their packaging until immediately before you intend to use them.
  - ▶ Always place the tattoo machine down so that the needle cartridge is not on it.
  - ▶ Seek medical attention if injured by a contaminated needle.
- ▶ Turn the tattoo machine off completely.

- ▶ Insert the needle cartridge in the opening in the grip, as illustrated below.

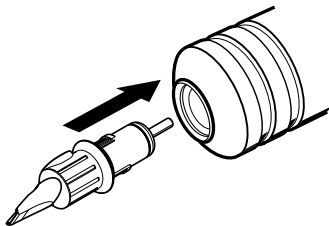

Due to its locating points on the top and bottom, each needle cartridge can only fit in the oval opening in two ways.

- ▶ Rotate the needle cartridge clockwise by approx. 45°. As you rotate it, the multiple locating points will engage audibly until the needle cartridge is firmly locked into position.

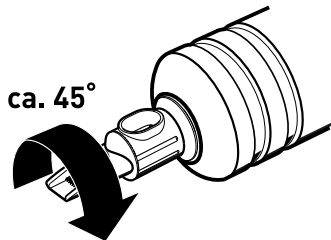

- ▶ Check that the needle cartridge is firmly seated.
- ▶ To remove the needle cartridge, turn it anti-clockwise and remove it from the grip.

## 6 Using the tattoo machine

### 6.1 Setting the needle depth

#### ⚠ CAUTION

##### Risk of injury from excessive needle depth

A large needle depth permits a deep piercing depth. If needle depth and piercing depth are excessive, this can damage the subcutaneous layer.

- ▶ Start with just a short length of needle depth.
- ▶ Start the tattoo machine.
- ▶ Adjust the needle depth while the machine is switched on; to do this, turn the grip.

Turning clockwise increases the needle depth:

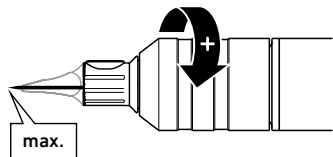

Turning counterclockwise reduces the needle depth:

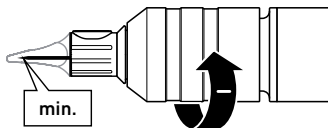

- ▶ Check the needle depth status of the machine.

If the needle depth status is altered accidentally during operation because the grip does not remain fixed in position, clean the inside of the grip, the thread of the drive, the grooves and the small o-ring thoroughly (see chapter 7.5 on page 40). If the problem continues, replace the small o-ring as well (see chapter 7.7 on page 40). If the problem still persists, consult your local specialist re-tailer.

### 6.2 Setting the stitch frequency

#### ⚠ CAUTION

##### Risk of injury due to high stitch frequency

If the stitch frequency is too high, the skin can be cut.

- ▶ Always start at a low stitch frequency.
- ▶ Start the tattoo machine.
- ▶ Set an appropriate stitch frequency. The stitch frequency must suit the characteristics of the customer's skin, the needle depth and the individual piercing depth when working, as well as the operating speed.

### 6.3 Setting the stroke

#### ⚠ CAUTION

##### The stroke setting changes the needle depth

If needle depth and piercing depth are excessive, this can damage the subcutaneous layer.

- ▶ Each time after adjusting the stroke, re-adjust the needle depth.

You can infinitely adjust a stroke from 2.5 mm to 4.0 mm on the machine.

There are two additional locking positions between the end positions for 3.0 and 3.5 mm stroke, which you can easily identify by the semi-circular scaling. You can set the positions between the locking settings as well.

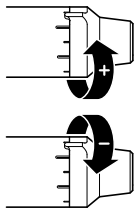

You can turn the rear sleeve by 180° to set the stroke position:

- ▶ Turn the rear sleeve to the desired position.
- ▶ Each time after adjusting the stroke, re-adjust the needle depth.

## 6.4 Loading with ink

- ▶ Immediately before use, dip the tip of the needle cartridge in the desired color of ink for 2 to 3 seconds with the unit running. Avoid contact with the ink container. The ink is picked up by the needles. Alternatively, the ink can be filled into the opening on the needle cartridge using a sterile pipette.

## 7 Cleaning and maintaining the tattoo machine

### ⚠ CAUTION

#### Risk of short-circuit

If components of the tattoo machine are dismantled and cleaned while still powered, there is a risk of damage to the electronics in the drive unit.

- ▶ For any cleaning and maintenance work, always disconnect the tattoo machine completely from its voltage source (power unit or power adapter).

### NOTICE

#### Damage to drive caused by fluid

If cleaning fluid or disinfectant gets inside the drive, this can corrode the electrical and mechanical components.

- ▶ Never immerse the drive in disinfectant.
- ▶ Never use an autoclave or an ultrasonic bath to clean the drive and the connecting cable.
- ▶ Pay attention to compatibility of materials when selecting cleansers and disinfectants (see chapter 7.1 on page 38).

### 7.1 Material compatibilities

- ▶ Wherever possible, use one of the following disinfectants:

Manufacturer	Product	Exposure time
Antiseptica	Big Spray "new"	1 to 5 mins
Bode Chemie	Bacillol	30 s to 1 min
Ecolab	Incidin Foam	1 to 2 mins

Manufacturer	Product	Exposure time
Schülke & Mayr	Mikrozid Liquid	1 to 2 mins

Based on the following material compatibilities, you can assess which other cleaning agents and disinfectants are suitable.

The anodized aluminum components and seals of the tattoo machine are **resistant** to:

- Weak acids (e.g. boric acid  $\leq 10\%$ , acetic acid  $\leq 10\%$ , citric acid  $\leq 10\%$ )
- Aliphatic hydrocarbons (e.g. pentane, hexane)
- Ethanol
- Most inorganic salts and their aqueous solutions (e.g. sodium chloride, calcium chloride, magnesium sulphate)

The anodized aluminum components and seals of the tattoo machine are **not resistant** to:

- Strong acids (e.g. hydrochloric acid  $\geq 20\%$ , sulphuric acid  $\geq 50\%$ , nitric acid  $\geq 15\%$ )
- Oxidizing acids (e.g. peracetic acid)
- Lyes (e.g. caustic soda, ammonia and all substances with a pH value  $> 7$ )
- Aromatic/halogenized hydrocarbons (e.g. phenol, chloroform)
- Acetone and benzene

## 7.2 Disinfecting surfaces

Before and after each usage:

- ▶ Disinfect all surfaces of the tattoo machine and its accessories as described in chapter 5.2 on page 33.

## 7.3 Cleaning surfaces

In the event of external contamination:

- ▶ Disassemble the grip and drive.
- ▶ Wipe the grip, the drive and the protective sleeve with a soft cloth dipped in a cleaning agent or a disinfectant.

- ▶ Clean inaccessible surfaces, e.g. the thread of the drive unit, with a soft-bristled nylon brush or a swab.
- ▶ Note that due to the surface quality, streaks of ink may occur on the tattoo machine.

## 7.4 Cleaning the drive ram

If the module shaft is dirty, you can separate the grip mount from the machine to better access and clean the drive ram.

- ▶ Completely unscrew the grip (1) from the drive.

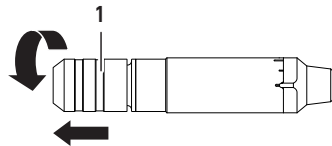



- ▶ Use the supplied service wrench (hexagon socket, size 1.5 mm) (1) or an identical tool to loosen the grip mount and remove it (2).

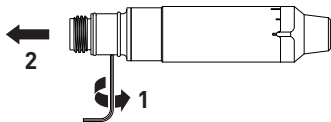

- ▶ Clean the protruding drive ram and the adjacent surfaces. Make sure that no liquid penetrates into the machine.

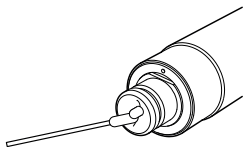

- ▶ Place the cleaned grip mount on the machine (1). Make sure that the nose on the guide sleeve dips into the recess on the machine and that the surfaces are flush with each other. This is the only way to set the needle depth correctly afterwards.

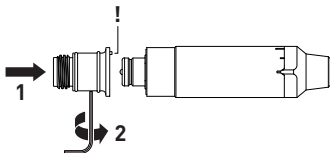

- ▶ Carefully tighten the grip mount again by hand-tightening the set screw (max. torque 0.2 Nm) (2). Too much force may cause permanent damage to the thread and the machine.

### 7.5 Cleaning grip in an ultrasonic bath

If the grip is severely soiled:

- ▶ Use cleaning agent Tickomed 1 or Tickopur R33 from manufacturer Dr. H. Stamm GmbH in accordance with the manufacturer's instructions.

- ▶ Make sure that a pH value of 7 is not exceeded.
- ▶ Conduct the cleaning operation for 10 minutes at a frequency of 35 kHz.
- ▶ Dry the grip entirely after cleaning before you reuse it.

### 7.6 Sterilizing grip in an autoclave

Whenever grip is contaminated:

- ▶ Perform all steps described in chapter 5.2 on page 33.
- ▶ Autoclave the grip for 20 minutes at a temperature of 121 °C and a pressure of 2 bar.
- ▶ Dry the grip entirely after cleaning before you reuse it.

### 7.7 Cleaning or replacing o-rings

Both o-rings prevent the grip from being turned too easily.

If it is too easy to turn the grip, causing the needle depth to alter accidentally:

- ▶ Degrease the o-ring with a soft cloth dipped in a cleaning agent or a disinfectant.

- ▶ If the problem persists, replace the o-rings with new ones and if necessary, grease them with silicone grease.

## 8 Transport and storage conditions

### NOTICE

#### Damage to product caused by dropping it

If the tattoo machine is dropped, its motor can be damaged.

- ▶ Always set the tattoo machine down carefully so that it cannot fall.
- ▶ If the tattoo machine does fall, perform a visual inspection and a test for unusual noises.
- ▶ Deliver the tattoo machine to a specialist retailer for inspection if it has visible signs of damage, if the operating noise level changes significantly or if it stops functioning normally.

- ▶ Always transport your tattoo machine and its accessories ensuring they are sufficiently padded. Leave the grip attached during transport to protect the drive.
- ▶ Always store your tattoo machine and accessories under the following conditions:

Ambient temperature	-40 °C to +50 °C -40 °F to +122 °F
Relative humidity	30% to 75%
Air pressure	200 hPa to 1060 hPa

## 9 Disposal of equipment



- ▶ Dispose of the machine and accessories bearing the following designation in accordance with the applicable regulations for used electronic equipment (WEEE Directive 2012/19/EU). If necessary, consult the specialist retailer or the responsible authorities to learn about applicable regulations for used electronic equipment.

- ▶ At the workplace, have containers available that allow contaminated parts to be disposed of properly.
- ▶ Dispose of used or defective needle cartridges in a see-through container (safety box) in accordance with the regulations applicable in your country.

## 10 For questions or problems

If there is a malfunction:

- ▶ First disconnect and remove all components from the tattoo machine.
- ▶ Check all connections and contacts and then reassemble the components.
- ▶ Check the functions of the machine again.

If malfunctions persist, and if you have any questions or complaints, please contact the specialist retailer responsible.

To obtain information about our current offers, the selection of needle cartridges and accessories, please visit our website [www.cheyennetattoo.com](http://www.cheyennetattoo.com).

## 11 Manufacturer Declarations

---

### 11.1 Disclaimer of warranties

With the Cheyenne tattoo machine HAWK Pen Unio you have purchased a high-quality brand product.

The reliability of this machine is assured through application of the latest inspection technologies and certification. MT.DERM GmbH is certified in accordance with DIN EN ISO 13485:2016 (quality management system for medical products).

A warranty period of one year applies to malfunctions resulting from defects in material and workmanship for the product.

For the needle cartridges, we guarantee sterility until the indicated expiration date subject to sealed and undamaged packaging, and to compliance with transport and storage conditions. The "expiration date" is indicated on the module label. For complaints relating to needle cartridges, please advise us of the batch number printed on the label.

We do not provide warranty cover in respect of the following types of damage:

- Damage and secondary damage arising from unintended use or failure to comply with the operating manual.
- Damage arising from the ingress of fluids or dirt into the drive
- Damage and secondary damage arising from dropping it or it falling

## 11.2 Declaration of Incorporation

Declaration of Incorporation according to Machinery Directive 2006/42/EC, Annex II 1 B (Supply of Machinery (Safety) Regulations 2008):

Manufacturer

MT.DERM GmbH  
Blohmstrasse 37-61  
12307 Berlin, Germany

Authorized representative for compiling the relevant technical documentation

Dr. Andreas Pachten  
MT.DERM GmbH  
Blohmstrasse 37-61  
12307 Berlin, Germany

Product designation

Tattoo machine

Product name

HAWK Pen Unio

Item number

CB5250401, CB5250402, CB5250403, CB5250404, CB5250405, CB5250406

The manufacturer hereby declares that the products indicated above is an incomplete machine within the meaning of the Machinery Directive. The products are intended exclusively for installation into a machine or incomplete machine and as such does not meet all the requirements of the Machinery Directive.

Machinery Directive requirements / machinery regulations applied or complied with: 1.1.2; 1.1.3; 1.1.5; 1.1.6; 1.2.2; 1.2.4.3; 1.2.6; 1.3.1; 1.3.2; 1.3.3; 1.3.4; 1.3.7; 1.3.8; 1.3.8.1; 1.3.9; 1.4.1; 1.5.1; 1.5.2; 1.5.4; 1.5.5; 1.5.6; 1.5.8; 1.5.9; 1.5.10; 1.5.11; 1.5.13; 1.6.1; 1.6.3; 1.6.4; 1.7.1; 1.7.1.1; 1.7.2; 1.7.3; 1.7.4; 1.7.4.1; 1.7.4.2; 1.7.4.3; 2.1.1; 2.1.2; 2.2.1; 2.2.1.1

The special technical documentation according to Appendix VII Part B has been established. The person authorized to compile the technical documentation agrees to hand over the documentation upon justified request by the national authorities. The transfer will be made by mail in paper form or on an electronic data medium.

It is forbidden to operate the product until it has been determined that the machine in which the aforementioned product is to be installed meets all fundamental requirements of the Machinery Directive.

The aforementioned product meets the requirements of the following relevant directives:

EU  
EMC Directive 2014/30/EU

UK  
Electromagnetic Compatibility Regulations 2016

RoHS Directive 2011/65/EU

The Restriction of the Use of Certain Hazardous Substances in Electrical and Electronic Equipment Regulations 2012

The following standards were applied:

EN 55014-1:2017/A11:2020

Electromagnetic Compatibility - Requirements for household appliances, electric tools and similar apparatus - Part 1: Emitted interference

EN 55014-2:2015

Electromagnetic Compatibility - Requirements for household appliances, electric tools and similar apparatus - Part 2: Immunity

This declaration is issued on behalf of the manufacturer by:

Berlin, dated 8/1/2021, Jörn Kluge



---

(Signature of CEO or deputy)

Original



**MT.DERM GmbH** · Blohmstraße 37-61 · 12307 Berlin · Germany

fon: +49 (0)30-767662200

web: [www.cheyennetattoo.com](http://www.cheyennetattoo.com)

e-mail: [info@cheyennetattoo.com](mailto:info@cheyennetattoo.com)